

Disc-Lock™

The Disc-Lock™ Safety Wheel Nut is a vibration-proof wheel nut, specifically designed to prevent wheel loss from commercial vehicles such as trucks, trailers, and buses with spigot mounted wheel fixings.

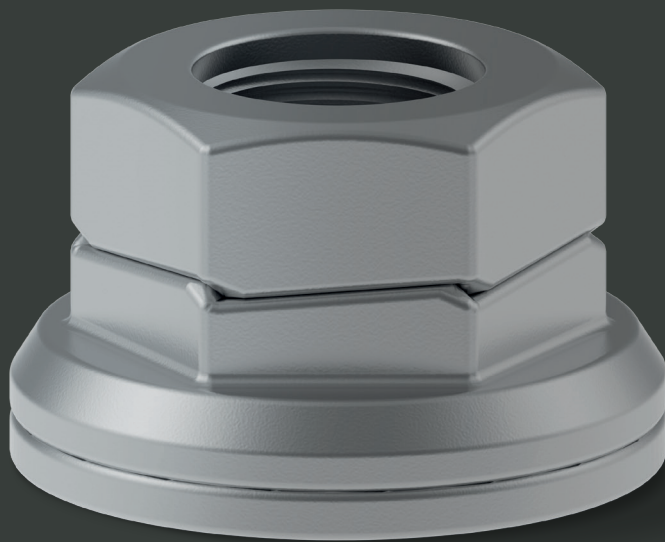

Disc-Lock™

Product: Disc-Lock™ M14
Product Code: DLM14

Function: The Disc-Lock™ works based on the angle of the cams on the wheel nut being greater than the angle of the thread on the stud.

In order to loosen under vibration the locking nut would have to rise over the interlocking cams, however this is physically prevented due to the difference in pitch angles.

The Disc-Lock™ range is Greenkoted®. This hard-wearing coating gives exceptional corrosion resistance and durability. This provides another advantage over standard wheel nuts which can be susceptible to corrosion and lead to further wheel fixing issues.

Material: The Disc-Lock™ wheel nut is steel - Class 10 and conforms to ISO 898 Part 2

Application: Mainly for commercial vehicles such as trucks, particularly high value/dangerous goods transporters. This is also popular for waste management vehicles and public service vehicles.

Main benefits: Helps prevent wheel loss. Simple to install. Improves driver productivity. Reduces operating and service costs. Coated with Greenkote®.

Sizes: M12, M14, M16, M18, M20, M22 and Scania nut sizes.

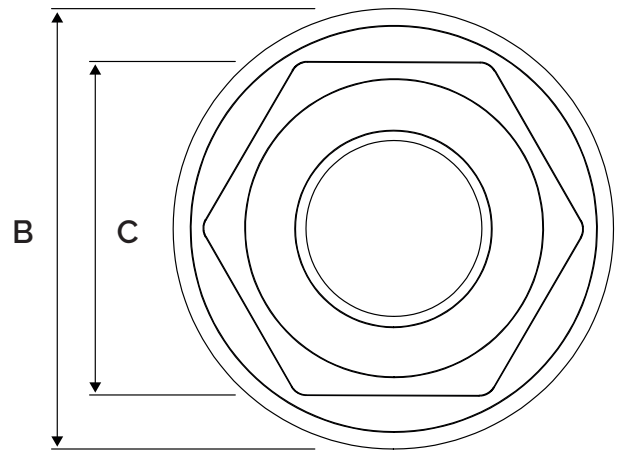
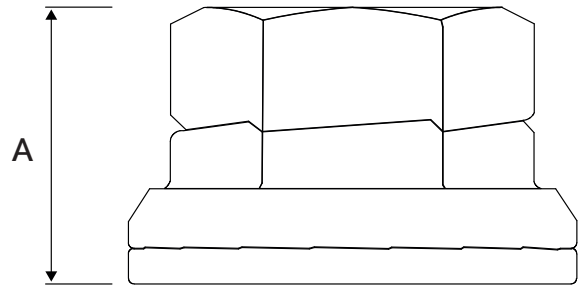

Specifications:

- A = 21 mm
- B = 32 mm
- C = 24 mm



**GLOBAL LEADERS
 IN WHEEL SAFETY**

Tel: +44 (0)1524 271 200
 info@checkpoint-safety.com
 www.checkpoint-safety.com